

ELITE SIGNS

STAND OUT. WIN BIG.



ELITE SIGNS
SIGNAGE BROCHURE 2025

WHAT IF YOUR BRAND WAS THE FIRST THING PEOPLE NOTICED?

Imagine your business standing out on a bustling high street, your logo catching every passerby's eye, and your message resonating long after they've walked by.

At Elite Signs, we turn that "what if" into reality.

We don't just make signs - we create visual experiences that will make your business shine and stand out from the competition.

With over 25 years of experience, we understand the power of strong branding and the unique challenges businesses face today.

Whether you're looking to elevate your brand presence, enhance customer experience, or ensure your signage reflects the quality of your business, we're here to make it happen.

Our team of skilled designers, craftsmen, and installers are dedicated to delivering bespoke signage solutions that not only meet your needs but exceed your expectations. At Elite Signs, your brand's success is not just a goal; it's our top priority. This brochure contains everything you need to make your brand impossible to ignore.

We've included all the information you need to make an informed decision about your branding and signage needs.

So, are you ready to elevate your brand, capture attention, and make that unforgettable first impression? Let's explore the comprehensive range of solutions at your disposal to make your business stand out and win big.

FLAT BOARD SIGNAGE: COST-EFFECTIVE, RELIABLE, AND READY FOR ACTION

When you need signage that gets the job done without stretching your budget, our flat board range is your go-to solution. With four different substrate options to choose from, each one offers its own unique benefits based on your specific needs.



FLUTED BOARD (ALSO KNOWN AS CORREX)

The perfect choice for short-term projects or events, Correx is ideal for site signage or one-day events.

- Low-Cost Solution: Keeps your budget in check.
- Lightweight and Flexible: Made from fluted plastic, this board is ultralight and easy to handle.
- Temporary Use: Best for short-term applications where quick setup and removal are key.
- For internal/external use.



PVC RIGID FOAM (ALSO KNOWN AS FOAMEX)

Looking for something more durable? Foamex steps up with a more rigid structure, great for smaller signs.

- Affordable and Strong: PVC board that offers a balance of strength and cost-effectiveness.
- Versatile: Suitable for medium-term use in various settings.
- Available in various size thicknesses and still lightweight for easy installation.
- For internal/external use.



ACRYLIC

For a more polished look, acrylic delivers sleek, long-lasting results, perfect for interior settings.

- Premium Finish – Acrylic is available in many colours (swatch available to view at Elite Signs) and either a Matt or Gloss finish. Acrylic offers a modern, clean appearance.
- Durability you can count on: Available in various thicknesses for a strong, lasting impression and can be used internally or externally.
- Acrylic can be shaped to your logo or text and can be mounted with stand-off locators for added depth and wow factor.

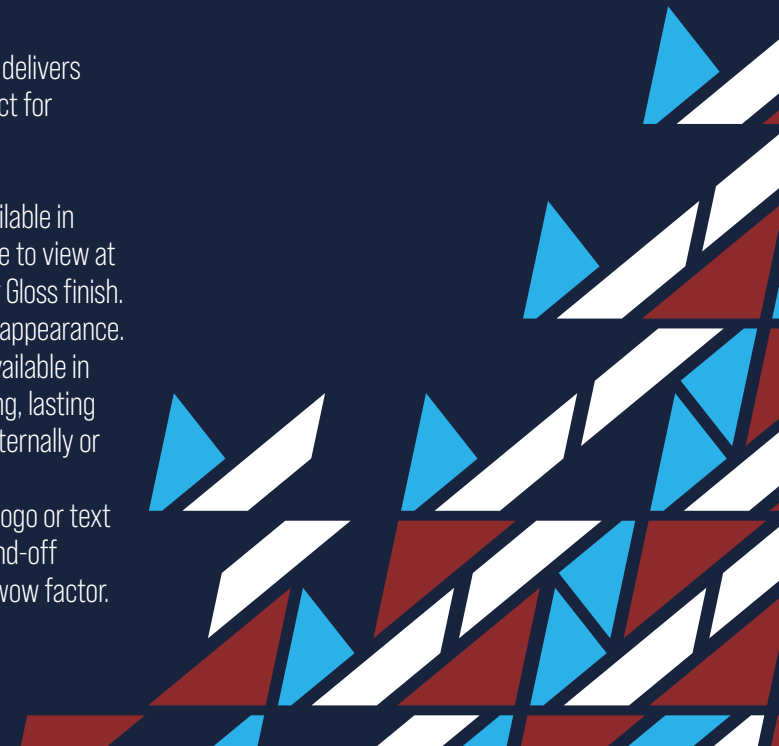

ALUMINIUM COMPOSITE PANELS (ALSO KNOWN AS DI-BOND, DI-LITE, SKYBOND)

Crafted from two layers of aluminium bonded to a solid polyethylene core for use internally or externally. Aluminium composite provides a sleek, professional finish while being incredibly strong and weather resistant. Here at Elite Signs, we only use premium quality materials.

This material can also be shaped to customers designs.

Customisable to your specifications, aluminium composite is perfect for indoor or outdoor use and can be used with digital print and gloss or matt laminated graphics applied to the front.

- Long term use.
- Suitable for internal & external use.
- 3mm thick.
- Heavy duty.
- Weatherproof.
- Can be cut to shape & customised.



SIGN TRAYS: ROBUST AND SEAMLESS

Our sign trays provide a long-lasting and sleek signage solution for maximum durability and impact. Sign trays can be made out of aluminium composite or solid sheet aluminium (size of sign will determine the best material to use). They are a great alternative to regular flat panel signs, giving you greater options for adding illuminated/non-illuminated 3D letters, acrylic letters, digitally printed and gloss/matt laminated graphics or flat cut vinyl.

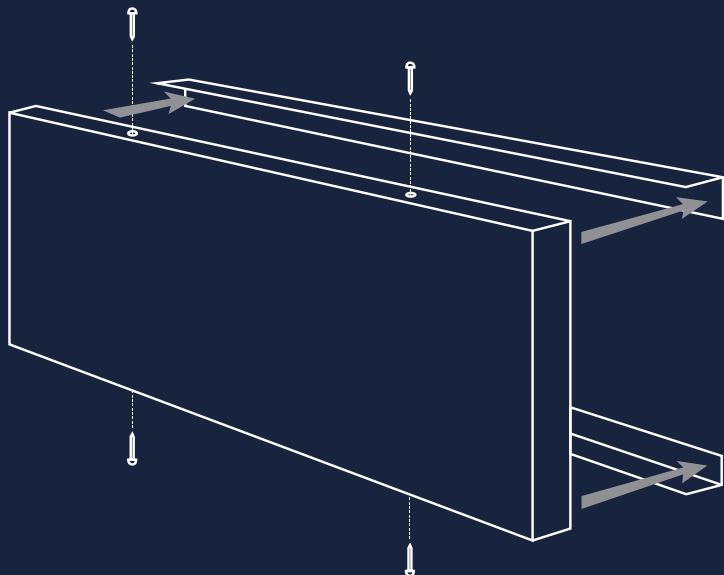

- Long term use – built for exterior durability.
- Sign trays provide a face with no visible fixings and returns with a depth of between 15mm and 140mm.
- Seamless finish ensures a clean, polished look.
- Available in a wide range of colours.
- 3D Letters/logos (illuminated and non-illuminated options available), acrylic letters and aluminium composite letters/logos can be fitted to the front of sign trays.
- Digitally printed and gloss/matt laminated graphics can be bonded to the front.



POST MOUNTED SIGNS: INFORMATIVE AND PROFESSIONAL

Post mounted signs are the ideal solution for businesses that need clear and professional signage in high traffic areas like roadsides, industrial estates and business parks. They are perfect for conveying directional information or identifying your business location.

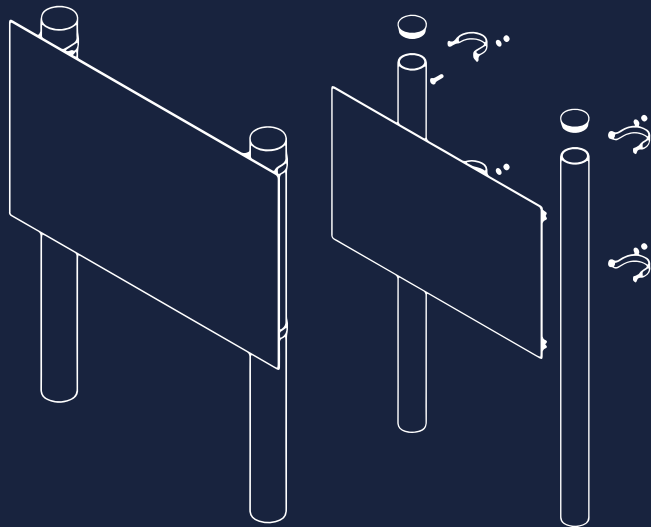

- With clip extrusions blind riveted to the rear.
- Available in various panel and post sizes.
- Can be shaped.
- Powder coating options available.
- Versatile application: Perfect for roadside, business park, or estate signage.
- Informative: Provides clear directional information to guide customers.



STAND-OFF LETTERS: ADD SOPHISTICATION TO YOUR SPACE

For a modern, sleek presentation, stand-off letters are an excellent choice. These acrylic or Di-Bond flat-cut letters create a three-dimensional effect, enhancing your brand's visibility.

- Material options: Choose from Acrylic or Di-Bond for a premium finish.
- Indoor or outdoor use: Versatile and stylish, no matter where they're installed.
- Depth and dimension: Stand off the surface for added visual impact.
- Thickness options: Available in 3mm, 5mm, or 10mm for customisation.

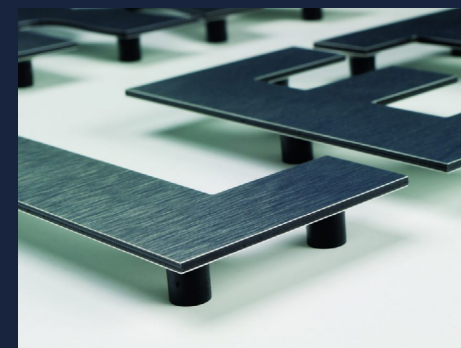
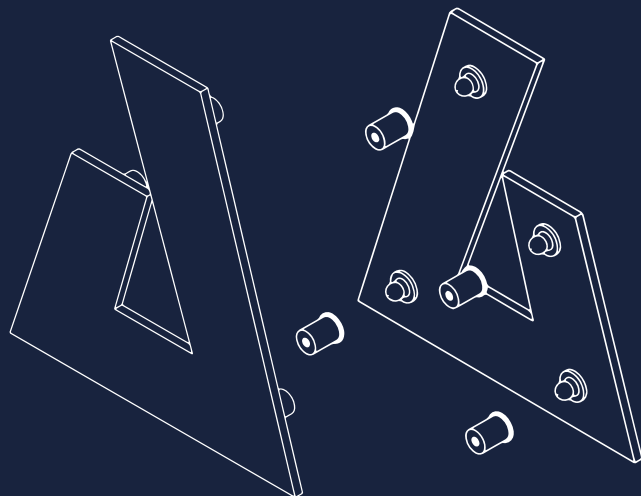

BUILT UP STAINLESS STEEL LETTERS: ILLUMINATED BRILLIANCE

Built up letters offer a premium professional look to your signage. These are perfect for businesses looking to add that touch of elegance.

Options of: Illuminated - Halo Lit, Front Lit and Non illuminated.

- Built-up letters can be customised with various illumination options.
- Suitable for indoor or outdoor use.
- Powder coated to any standard RAL colour.
- Customisable finishes.
- Available in various materials – Stainless, brass, copper, bronze and more.

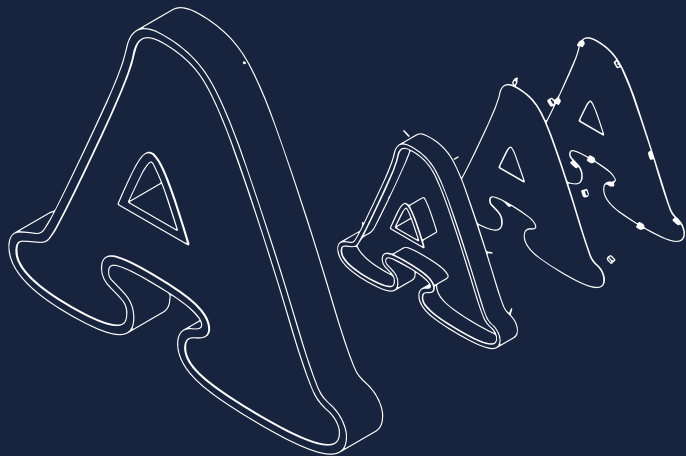

HALO ILLUMINATED: SOFT GLOW, BIG IMPACT

With LED's positioned behind each letter, the light creates a halo effect that elevates your signage appearance.

- Halo illumination: Creates a glowing effect around each letter.
- Various colours and finishes: Fully customisable to fit your brand.
- Thickness: 60mm thick letters for strong visual presence.
- Indoor or outdoor use: Suitable for any business setting.

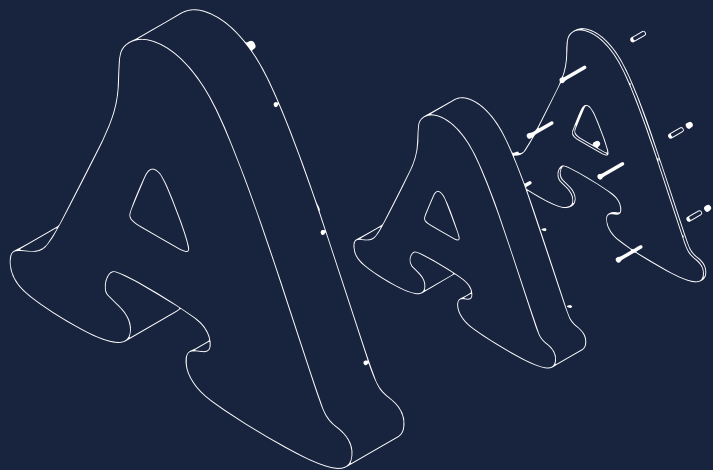

FRONT-LIT LETTERS

If you want your signage to shine and stand-out, front-lit letters are the way to go. Our illuminated 3D letters/logos are supplied with everything you need including wiring, fixings and waterproof power drives.

- Bespoke signage.
- Durable – suitable for internal and external use.
- 3D effect.

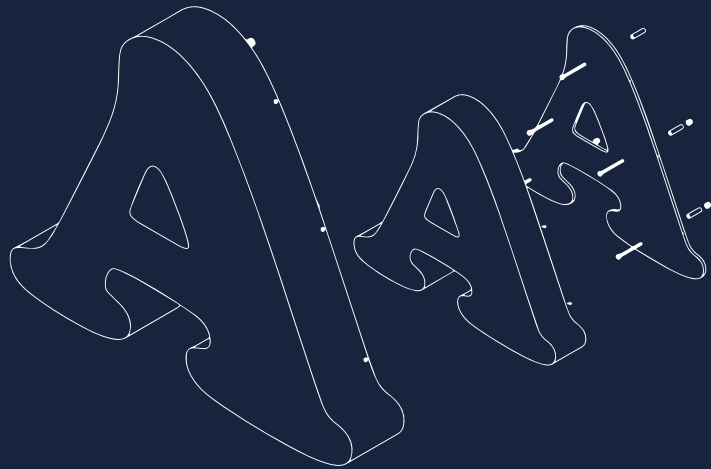

FRET CUT LED: BOLD AND ILLUMINATED

Fret cut LED signs offer a modern and bold solution. The lettering or logo is fretcut from a folded metal tray and powder-coated to match your brand colours, then backed with acrylic for a striking effect. We use a Backing Tray to house LEDs, Transformer and electrics and protect all components from moisture.

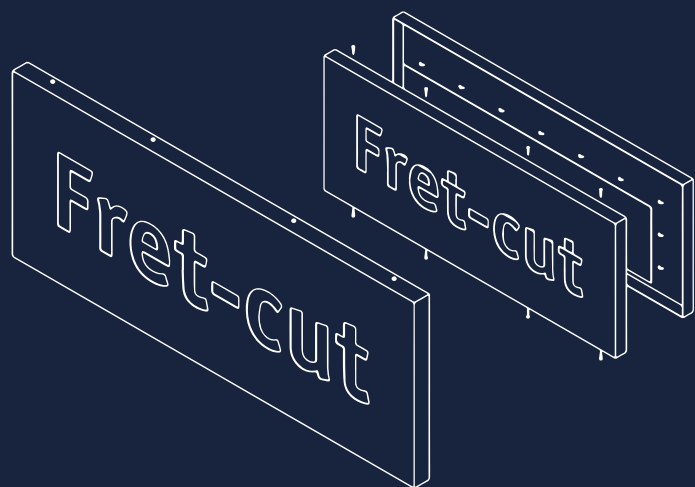

- Powder-coated tray: Ensures a flawless match to your branding.
- Backed with illuminated acrylic: Light shines through for a vibrant, bold look.
- Indoor or outdoor use: Suitable for all environments.
- Thickness: 80mm thick tray for added durability and depth.

FLEX FACED SIGNS: *PERFECT FOR LARGER ONE PIECE SIGNS*

Flex face signage can be used for internal or external use and are ideal for when a sign exceeds the maximum sheet size of normal signage. These signs can go large! The face will be printed in 1 piece, therefore no joins will be visible from the face of the sign.

- Front 'skin' can be changed/updated in future.
- Full colour printed graphics and powder coated frames.
- Can be illuminated or non-illuminated.
- Suitable for internal or external use.

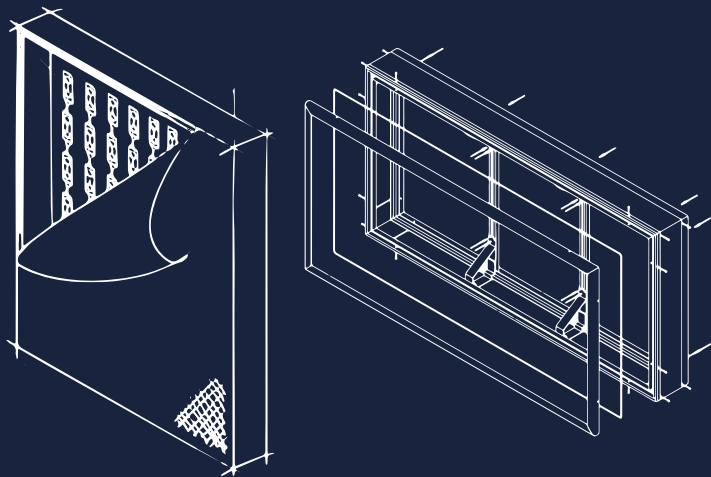

SCHOOL/COLLEGE SIGNAGE PROJECTS

We can create fun, colourful, informative, bespoke signage for schools using various materials. From shaped post mounted signs to window and wall graphics and logo mats.



WINDOW GRAPHICS / CONTRAVISION

ContraVision is one-way vision graphics allowing vision through from inside out, while displaying vibrant colours externally. ContraVision offers an innovative solution to both advertising and privacy without compromising on light.

Our externally applied one-way vision perforated films ensure prominent visibility for large and small-scale promotions. It allows advertising to be displayed on the exterior, while those inside can see out with minimal obstruction. Ideal for use on business premises, vehicles, retail storefronts, offices etc.



View from outside



View from inside looking out



BESPOKE PROJECTING SIGNS

Designed to literally stand-out, projecting signs are a great way to get noticed by passers-by. They project into the street above pedestrians heads where they are easily visible. These are made bespoke to your needs.

- Single or double sided swing signs available in various sizes and materials.
- Various mounting styles available.
- Can be illuminated or non-illuminated.



BESPOKE SIGNAGE: CUSTOM CREATIONS FOR YOUR VISION

At Elite Signs, we go beyond the ordinary. Our bespoke signage solutions are custom designed and manufactured to match your exact specifications. If you can dream it, we can create it!

Get in contact with one of our team to discuss your vision and our experts will work their magic to make them come to life.

- Full bespoke build: Custom designs tailored to your vision.
- Endless possibilities: From rustic finishes to polished metals.
- Indoor or outdoor use: Crafted to stand out in any environment.



BUSINESS CARDS

Our best selling high quality business cards are 85mm x 55mm on 450gsm silk with matt Lamination on both sides.

We believe a high quality business card sets the tone for your business and echoes the style used across all your signage and vehicle branding, so it not only makes a great first impression, but it creates a lasting connection too.

We use premium quality materials, which in this case is quality thick card as standard.

One-off Business Card artwork creation charge **£35 + VAT**

Print of 1 Set of 500x Business Cards 450gsm, deluxe, Matt Laminated, full colour both sides: **£75.00 + VAT each**

Print of 2 - 5 Sets of 500x Business Cards 450gsm, deluxe, Matt Laminated, full colour both sides: **£71 + VAT each**

Print of 5 - 9 Sets of 500x Business Cards 450gsm, deluxe, Matt Laminated, full colour both sides: **£66.00 + VAT each**

Print of 10 - 14 Sets of 500x Business Cards 450gsm, deluxe, Matt Laminated, full colour both sides: **£61.00 + VAT each**

(Sets; The same business card design but with multiple names & contact details within one order)

Other quantities are available: 1000, 1500, 2000, 2500, 3000, 3500 to 50,000

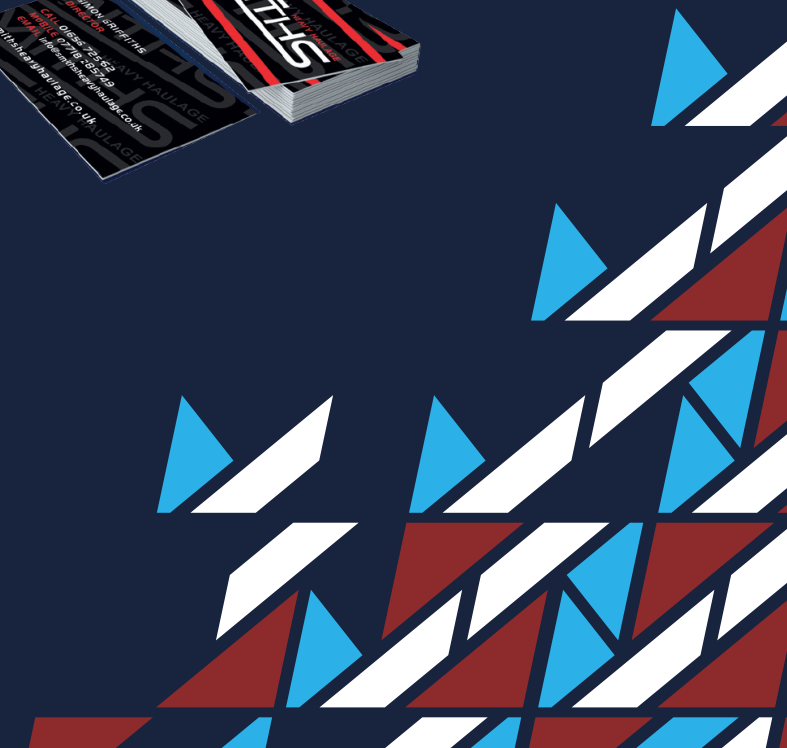

BANNER STANDS/POP-UP BANNERS

Banner stands are a perfect way to advertise your services. Promote your presence during trade events, information points in your office, photo back drops, showroom displays, reception areas and networking events.

- Lightweight, low cost and high quality.
- Comes with a carry bag.
- If you don't have a design, let us know and we can help with that.



A BOARDS / PAVEMENT SIGNS

The perfect advertising, information and directional solution and directional signage. Our outdoor free-standing signage is a powerful tool in the drive to increase sales or to share information to members of the public. It is also a great mobile tool for displaying health and safety information for trades people working on site.

- Many different sizes, designs and colour options available to choose from.
- Made to withstand the best and worst of the British weather.
- Can be single or double sided.
- Design service provided.

Also view our online sign and display catalogue by clicking on the QR code below:

SCAN ME!





HEAVY DUTY BANNERS WITH EYELETS

Our heavy duty banners are engineered from 510gsm coated vinyl for superior strength and resilience and will come with brass eyelets. Whether indoors or outdoors, these banners are ideal for events, businesses and impactful messages etc.

- Full colour heavy duty pvc banners with brass eyelets.
- Perfect for temporary advertising campaigns.
- Can be produced to almost any size.

LOGO MATS

Our logo mats feature your custom logo or artwork digitally printed from our 66 standard colours (we have a swatch available in our office). The surface is an Eco-friendly, 100% recycled PET carpet bonded to our premium 1.5mm Nitrile EXS rubber backing with reinforced 25mm borders.

- High quality print.
- Recycled materials.
- Durable.
- Washable.

FEATHER FLAGS & FLAGS

Feather flags are a great way of advertising for trade shows, exhibitions, forecourts, shopping centres, sports events etc.

- Available in a wide range of colours, shapes and sizes.
- Various bases available.
- Available in various sizes.

COMPLETE SIGNAGE MAKEOVER

Here at Elite Signs, we offer the complete package. From vehicle graphics to full business make-overs. We have in-house designers that will work with you to make your vision come to life.

From creating a logo to rebranding your business, we can help you to Stand Out, Win Big.



ELITE SIGNS

STAND OUT. WIN BIG.

CONTACT US

Elite Signs & Graphics Ltd.
Unit 2320 Central Park
Western Avenue
Bridgend Industrial Estate
Bridgend
CF31 3RH



Facebook



Instagram



Youtube



Flickr



Linkedin

+44 (0) 1656 661649

hello@elitesigns.co.uk
www.elitesigns.co.uk

